

SERIES N1A STOP GATE



www.HallidayProducts.com
 Phone 800-298-1027
 Fax 407-298-4534
 Sales@HallidayProducts.com

STANDARD FEATURES:

- ONE-PIECE 6061-T6 EXTRUDED ALUMINUM FRAME
- ONE-PIECE, WRAP AROUND POLYMER GUIDE
- 1/4" (7 MM) THICK 6061-T6 ALUMINUM GATE REINFORCED TO DEFLECT NO MORE THAN 1/360th OF SPAN
- LOW COEFFICIENT OF FRICTION
- NON-OZONE DEPLETING BITUMINOUS COATING ON FRAME
- DEEP SEATING FOR OPTIMUM TRACKING
- STANDARD "R" HANDLE OR OPTIONAL "P" HANDLE
- SERIES N1A AND N1C SUPPLIED WITH $\phi 1/2"$ (13 MM) MOUNTING HOLES AND S.STL. MOUNTING HARDWARE
- 3 YEAR GUARANTEE

QUANTITY
 SERIES N1A
 SERIES N1B
 SERIES N1C
 CHANNEL WIDTH
 CHANNEL HEIGHT
 GATE HEIGHT

SERIES N1A
(WALL MOUNTED)

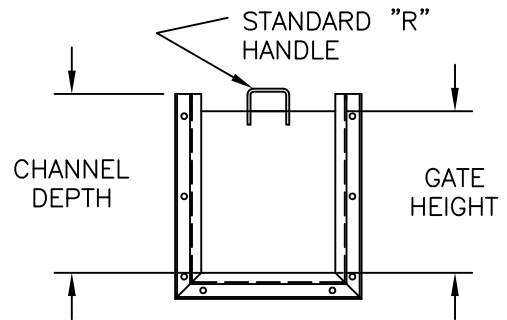
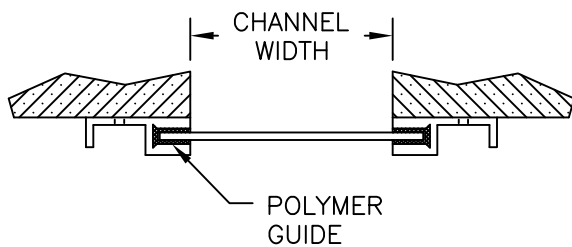

SERIES N1B
(EMBEDDED)

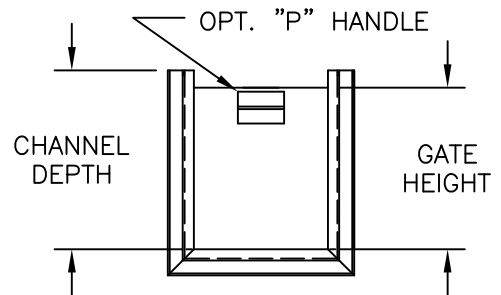
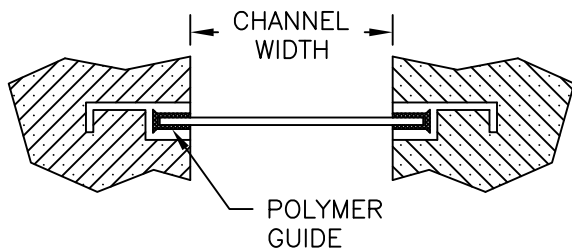

SERIES N1C
(IN-CHANNEL MOUNTED)

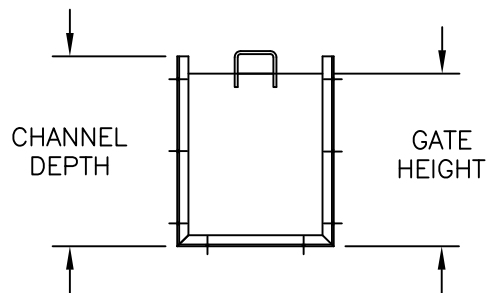
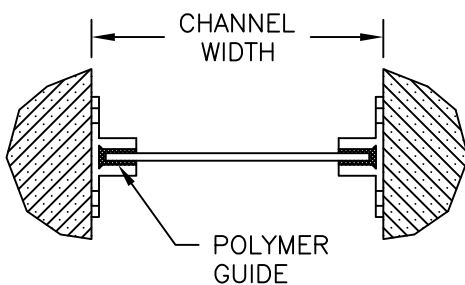

STANDARD
"R" HANDLE

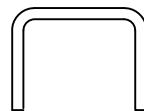

OPTIONAL
"P" HANDLE

